

74ALVC541

Octal buffer/line driver; 3-state

Rev. 02 — 5 November 2007

Product data sheet

1. General description

The 74ALVC541 is an octal non-inverting buffer/line drivers with 3-state bus compatible outputs. The 3-state outputs are controlled by the output enable inputs $\overline{OE}0$ and $\overline{OE}1$. A HIGH on $\overline{OE}n$ causes the outputs to assume a high-impedance OFF-state.

2. Features

- Wide supply voltage range from 1.65 V to 3.6 V
- Complies with JEDEC standard:
 - ◆ JESD8-7 (1.65 V to 1.95 V)
 - ◆ JESD8-5 (2.3 V to 2.5 V)
 - ◆ JESD8B/JESD36 (2.7 V to 3.6 V)
- 3.6 V tolerant inputs/outputs
- CMOS low power consumption
- Direct interface with TTL levels (2.7 V to 3.6 V)
- Power-down mode
- Latch-up performance exceeds 250 mA
- ESD protection:
 - ◆ HBM JESD22-A114E exceeds 2000 V
 - ◆ MM JESD22-A115-A exceeds 200 V

3. Ordering information

Table 1. Ordering information

Type number	Package			Version
	Temperature range	Name	Description	
74ALVC541D	-40 °C to +85 °C	SO20	plastic small outline package; 20 leads; body width 7.5 mm	SOT163-1
74ALVC541PW	-40 °C to +85 °C	TSSOP20	plastic thin shrink small outline package; 20 leads; body width 4.4 mm	SOT360-1
74ALVC541BQ	-40 °C to +85 °C	DHVQFN20	plastic dual-in-line compatible thermal enhanced very thin quad flat package no leads; 20 terminals; body 2.5 × 4.5 × 0.85 mm	SOT764-1

4. Functional diagram

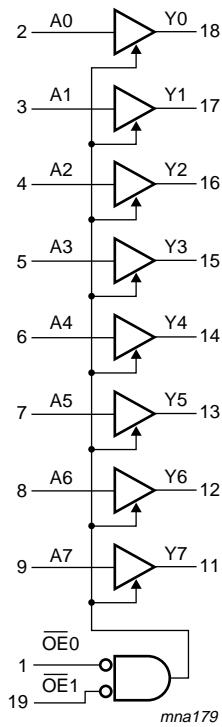

Fig 1. Logic symbol

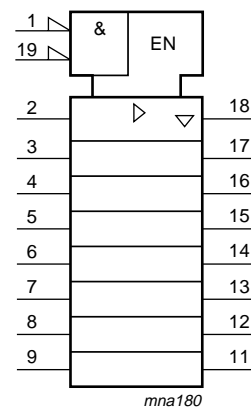
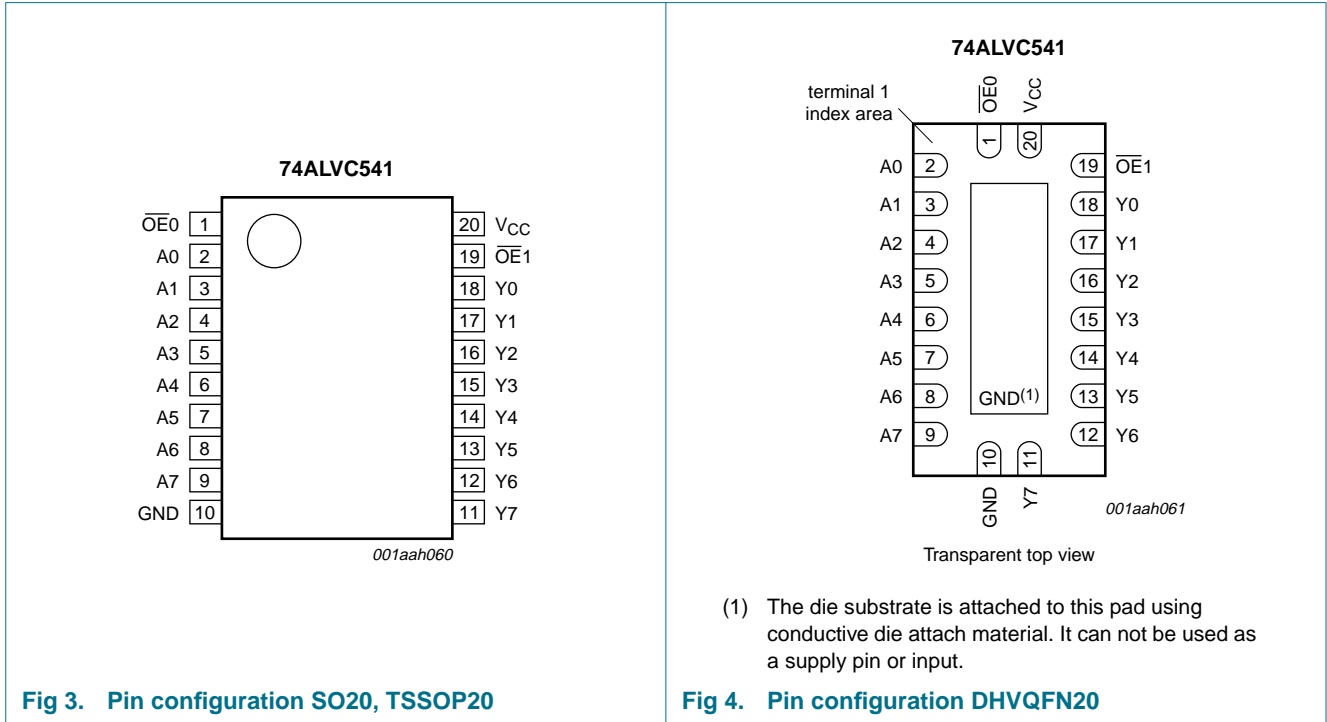

Fig 2. IEC logic symbol

5. Pinning information

5.1 Pinning



5.2 Pin description

Table 2. Pin description

Symbol	Pin	Description
$\overline{OE}0$	1	output enable input (active LOW)
A[0:7]	2, 3, 4, 5, 6, 7, 8, 9	data input
GND	10	ground (0 V)
Y[0:7]	18, 17, 16, 15, 14, 13, 12, 11	data output
$\overline{OE}1$	19	output enable input (active LOW)
V _{CC}	20	supply voltage

6. Functional description

Table 3. Functional table^[1]

Control		Input		Output
OE0	OE1	An	OE1	Yn
L	L	L	L	L
L	L	H	H	H
X	H	X	X	Z
H	X	X	X	Z

[1] H = HIGH voltage level; L = LOW voltage level; X = don't care; Z = high-impedance OFF-state.

7. Limiting values

Table 4. Limiting values

In accordance with the Absolute Maximum Rating System (IEC 60134). Voltages are referenced to GND (ground = 0 V).

Symbol	Parameter	Conditions	Min	Max	Unit
V _{CC}	supply voltage		-0.5	+4.6	V
V _I	input voltage		-0.5	+4.6	V
I _{IK}	input clamping current	V _I < 0 V	[1] -50	-	mA
I _{OK}	output clamping current	V _O > V _{CC} or V _O < 0 V	-	±50	mA
V _O	output voltage	output HIGH or LOW state	[2] -0.5	V _{CC} + 0.5	V
		output 3-state	[2] -0.5	+4.6	V
		power-down mode, V _{CC} = 0 V	[3] -0.5	+4.6	V
I _O	output current	V _O = 0 V to V _{CC}	-	±50	mA
I _{CC}	supply current		-	100	mA
I _{GND}	ground current		-100	-	mA
T _{stg}	storage temperature		-65	+150	°C
P _{tot}	total power dissipation	T _{amb} = -40 °C to +85 °C			
	SO20 package		[4] -	500	mW
	TSSOP20 package		[5] -	500	mW
	DHVQFN20 package		[6] -	500	mW

[1] The minimum input voltage ratings may be exceeded if the input current ratings are observed.

[2] The output voltage ratings may be exceeded if the output current ratings are observed.

[3] When V_{CC} = 0 V (Power-down mode), the output voltage can be 3.6 V in normal operation.

[4] P_{tot} derates linearly with 8 mW/K above 70 °C.

[5] P_{tot} derates linearly with 5.5 mW/K above 60 °C.

[6] P_{tot} derates linearly with 4.5 mW/K above 60 °C.

8. Recommended operating conditions

Table 5. Recommended operating conditions

Symbol	Parameter	Conditions	Min	Max	Unit
V_{CC}	supply voltage		1.65	3.6	V
V_I	input voltage		0	3.6	V
V_O	output voltage	output HIGH or LOW state	0	V_{CC}	V
		output 3-state	0	3.6	V
		power-down mode, $V_{CC} = 0$ V	0	3.6	V
T_{amb}	ambient temperature		-40	+85	°C
$\Delta t/\Delta V$	input transition rise and fall rate	$V_{CC} = 1.65$ V to 2.7 V	-	20	ns/V
		$V_{CC} = 2.7$ V to 3.6 V	-	10	ns/V

9. Static characteristics

Table 6. Static characteristics

At recommended operating conditions; voltages are referenced to GND (ground = 0 V).

Symbol	Parameter	Conditions	-40 °C to +85 °C			Unit
			Min	Typ ^[1]	Max	
V_{IH}	HIGH-level input voltage	$V_{CC} = 1.65$ V to 1.95 V	$0.65 \times V_{CC}$	-	-	V
		$V_{CC} = 2.3$ V to 2.7 V	1.7	-	-	V
		$V_{CC} = 2.7$ V to 3.6 V	2.0	-	-	V
V_{IL}	LOW-level input voltage	$V_{CC} = 1.65$ V to 1.95 V	-	-	$0.35 \times V_{CC}$	V
		$V_{CC} = 2.3$ V to 2.7 V	-	-	0.7	V
		$V_{CC} = 2.7$ V to 3.6 V	-	-	0.8	V
V_{OH}	HIGH-level output voltage	$V_I = V_{IH}$ or V_{IL}				
		$I_O = 100$ μ A; $V_{CC} = 1.65$ V to 3.6 V	$V_{CC} - 0.2$	-	-	V
		$I_O = 6$ mA; $V_{CC} = 1.65$ V	1.25	-	-	V
		$I_O = 12$ mA; $V_{CC} = 2.3$ V	1.8	-	-	V
		$I_O = 18$ mA; $V_{CC} = 2.3$ V	1.7	-	-	V
		$I_O = 12$ mA; $V_{CC} = 2.7$ V	2.2	-	-	V
		$I_O = 18$ mA; $V_{CC} = 3.0$ V	2.4	-	-	V
V_{OL}	LOW-level output voltage	$V_I = V_{IH}$ or V_{IL}				
		$I_O = -100$ μ A; $V_{CC} = 1.65$ V to 3.6 V	-	-	0.2	V
		$I_O = -6$ mA; $V_{CC} = 1.65$ V	-	-	0.3	V
		$I_O = -12$ mA; $V_{CC} = 2.3$ V	-	-	0.4	V
		$I_O = -18$ mA; $V_{CC} = 2.3$ V	-	-	0.6	V
		$I_O = -12$ mA; $V_{CC} = 2.7$ V	-	-	0.4	V
		$I_O = -18$ mA; $V_{CC} = 3.0$ V	-	-	0.4	V
I_{OZ}	OFF-state output current	$V_I = V_{IH}$ or V_{IL} ; $V_O = V_{CC}$ or GND; $V_{CC} = 3.6$ V	-	± 0.1	± 10.0	μ A

Table 6. Static characteristics ...continued

At recommended operating conditions; voltages are referenced to GND (ground = 0 V).

Symbol	Parameter	Conditions	-40 °C to +85 °C			Unit
			Min	Typ ^[1]	Max	
I _I	input leakage current	V _I = V _{CC} or GND; V _{CC} = 3.6 V	-	±0.1	±5.0	μA
I _{OFF}	power-off leakage current	V _I or V _O = 0 V to 3.6 V; V _{CC} = 0 V	-	±0.1	±10.0	μA
I _{CC}	supply current	V _I = V _{CC} or GND; I _O = 0 A; V _{CC} = 3.6 V	-	0.2	10	μA
ΔI _{CC}	additional supply current	per input pin; V _{CC} = 3.0 V to 3.6 V; V _I = V _{CC} - 0.6 V; I _O = 0 A;	-	5	750	μA
C _I	input capacitance		-	3.5	-	pF

[1] All typical values are measured at V_{CC} = 3.3 V and T_{amb} = 25 °C.

10. Dynamic characteristics

Table 7. Dynamic characteristics

Voltages are referenced to GND (ground = 0 V); for test circuit see [Figure 7](#).

Symbol	Parameter	Conditions	-40 °C to +85 °C			Unit
			Min	Typ ^[1]	Max	
t _{pd}	propagation delay	An to Yn; see Figure 5 ^[2]				
		V _{CC} = 1.65 V to 1.95 V	1.0	3.0	4.6	ns
		V _{CC} = 2.3 V to 2.7 V	1.0	2.2	3.3	ns
		V _{CC} = 2.7 V	1.0	2.5	3.3	ns
t _{en}	enable time	$\overline{\text{OEn}}$ to Yn; see Figure 6 ^[2]				
		V _{CC} = 1.65 V to 1.95 V	1.0	4.2	7.5	ns
		V _{CC} = 2.3 V to 2.7 V	1.0	3.3	5.4	ns
		V _{CC} = 2.7 V	1.0	3.7	5.8	ns
t _{dis}	disable time	$\overline{\text{OEn}}$ to Yn; see Figure 6 ^[2]				
		V _{CC} = 1.65 V to 1.95 V	1.0	4.8	7.5	ns
		V _{CC} = 2.3 V to 2.7 V	1.0	3.1	4.5	ns
		V _{CC} = 2.7 V	1.0	3.1	4.8	ns
		V _{CC} = 3.0 V to 3.6 V	1.0	2.9	4.6	ns

Table 7. Dynamic characteristics ...continued
 Voltages are referenced to GND (ground = 0 V); for test circuit see [Figure 7](#).

Symbol	Parameter	Conditions	-40 °C to +85 °C			Unit
			Min	Typ ^[1]	Max	
C _{PD}	power dissipation capacitance	per buffer; V _I = GND to V _{CC} ; V _{CC} = 3.3 V ^[3]				
		outputs enabled	-	25	-	pF
		outputs disabled	-	0	-	pF

- [1] All typical values are measured at T_{amb} = 25 °C and V_{CC} = 1.8 V, 2.5 V, 2.7 V and 3.3 V.
- [2] t_{pd} is the same as t_{PLH} and t_{PHL}.
 t_{en} is the same as t_{PZL} and t_{PZH}.
 t_{dis} is the same as t_{PLZ} and t_{PHZ}.
- [3] C_{PD} is used to determine the dynamic power dissipation (P_D in μW).
 $P_D = C_{PD} \times V_{CC}^2 \times f_i \times N + \Sigma(C_L \times V_{CC}^2 \times f_o)$ where:
 f_i = input frequency in MHz;
 f_o = output frequency in MHz;
 C_L = output load capacitance in pF;
 V_{CC} = supply voltage in V;
 N = number of inputs switching;
 Σ(C_L × V_{CC}² × f_o) = sum of the outputs.

11. Waveforms

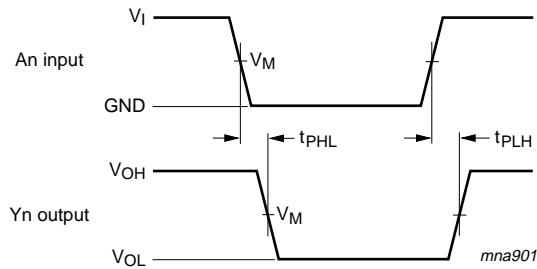

Measurement points are given in [Table 8](#).

V_{OL} and V_{OH} are typical voltage output levels that occur with the output load.

Fig 5. Propagation delay input (An) to output (Yn)

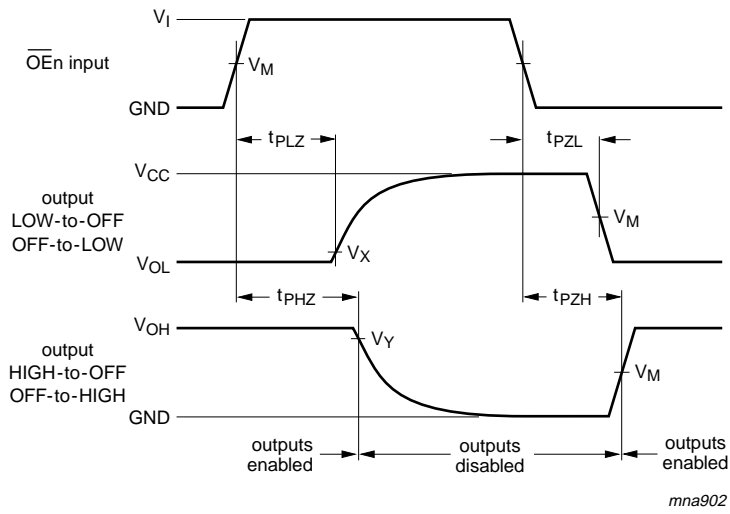

Measurement points are given in [Table 8](#).

V_{OL} and V_{OH} are typical voltage output levels that occur with the output load.

Fig 6. Enable and disable times

Table 8. Measurement points

Supply voltage	Input		Output		
V_{CC}	V_I	V_M	V_M	V_X	V_Y
1.65 V to 1.95 V	V_{CC}	$0.5 \times V_{CC}$	$0.5 \times V_{CC}$	$V_{OL} + 0.15 \text{ V}$	$V_{OH} - 0.15 \text{ V}$
2.3 V to 2.7 V	V_{CC}	$0.5 \times V_{CC}$	$0.5 \times V_{CC}$	$V_{OL} + 0.15 \text{ V}$	$V_{OH} - 0.15 \text{ V}$
2.7 V	2.7 V	1.5 V	1.5 V	$V_{OL} + 0.3 \text{ V}$	$V_{OH} - 0.3 \text{ V}$
3.0 V to 3.6 V	2.7 V	1.5 V	1.5 V	$V_{OL} + 0.3 \text{ V}$	$V_{OH} - 0.3 \text{ V}$

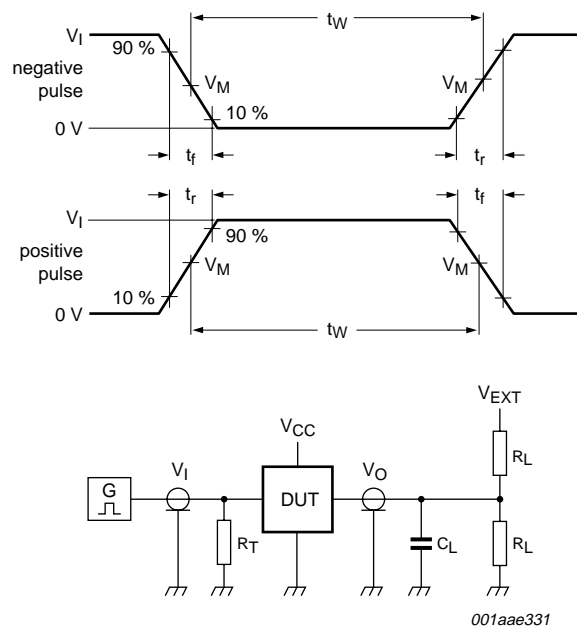

Test data is given in [Table 9](#).

Definitions test circuit:

R_T = Termination resistance should be equal to output impedance Z_o of the pulse generator

C_L = Load capacitance including jig and probe capacitance

R_L = Load resistor

Fig 7. Load circuitry for switching times

Table 9. Test data

Supply voltage	Input		Load		V_{EXT}		
V_{CC}	V_I	t_r, t_f	C_L	R_L	t_{PLH}, t_{PHL}	t_{PLZ}, t_{PZL}	t_{PHZ}, t_{PZH}
1.65 V to 1.95 V	V_{CC}	≤ 2.0 ns	30 pF	1 k Ω	open	$2 \times V_{CC}$	GND
2.3 V to 2.7 V	V_{CC}	≤ 2.0 ns	30 pF	500 Ω	open	$2 \times V_{CC}$	GND
2.7 V	2.7 V	≤ 2.5 ns	50 pF	500 Ω	open	6	GND
3.0 V to 3.6 V	2.7 V	≤ 2.5 ns	50 pF	500 Ω	open	6	GND

12. Package outline

SO20: plastic small outline package; 20 leads; body width 7.5 mm

SOT163-1

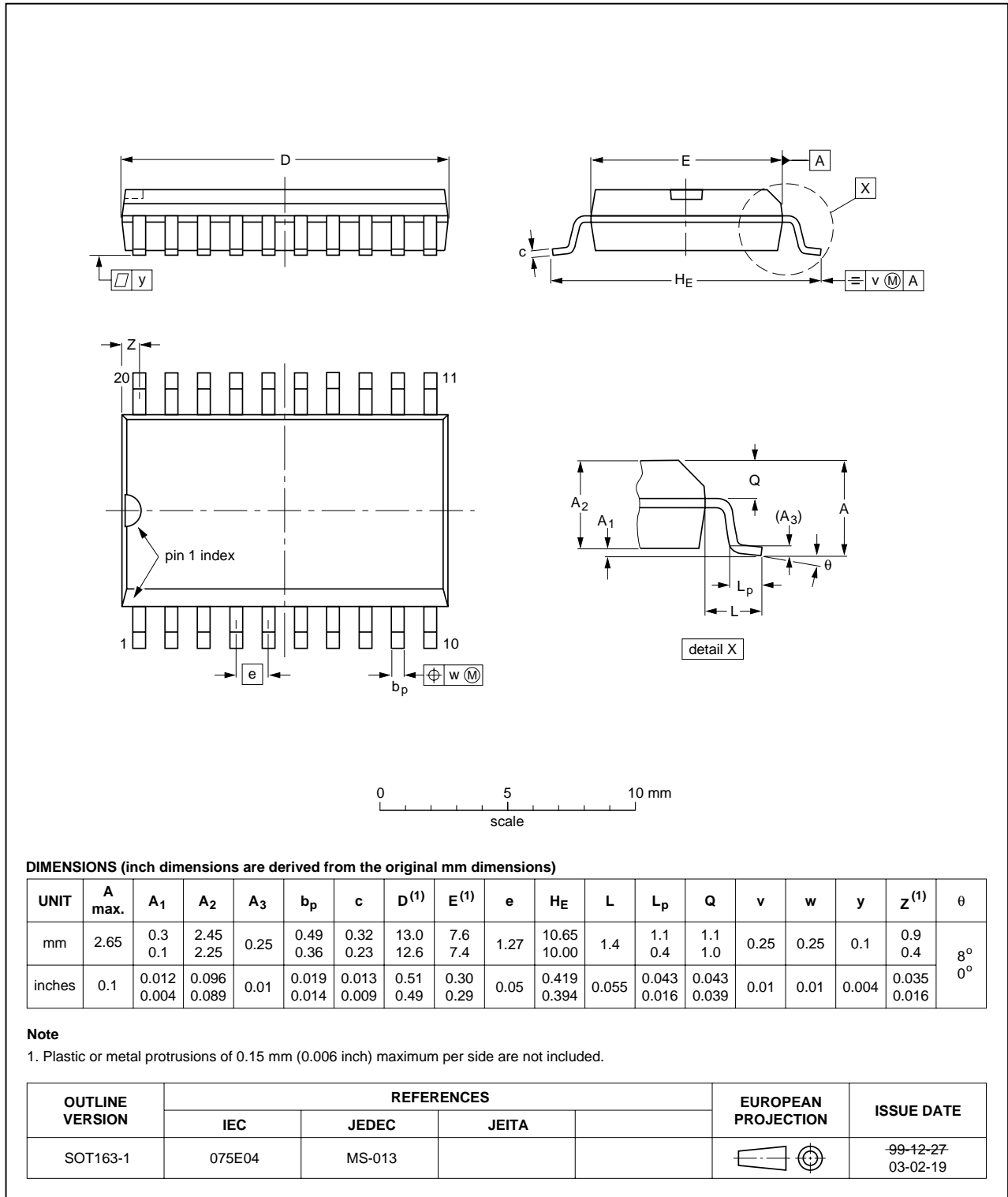

Fig 8. Package outline SOT163-1 (SO20)

TSSOP20: plastic thin shrink small outline package; 20 leads; body width 4.4 mm

SOT360-1

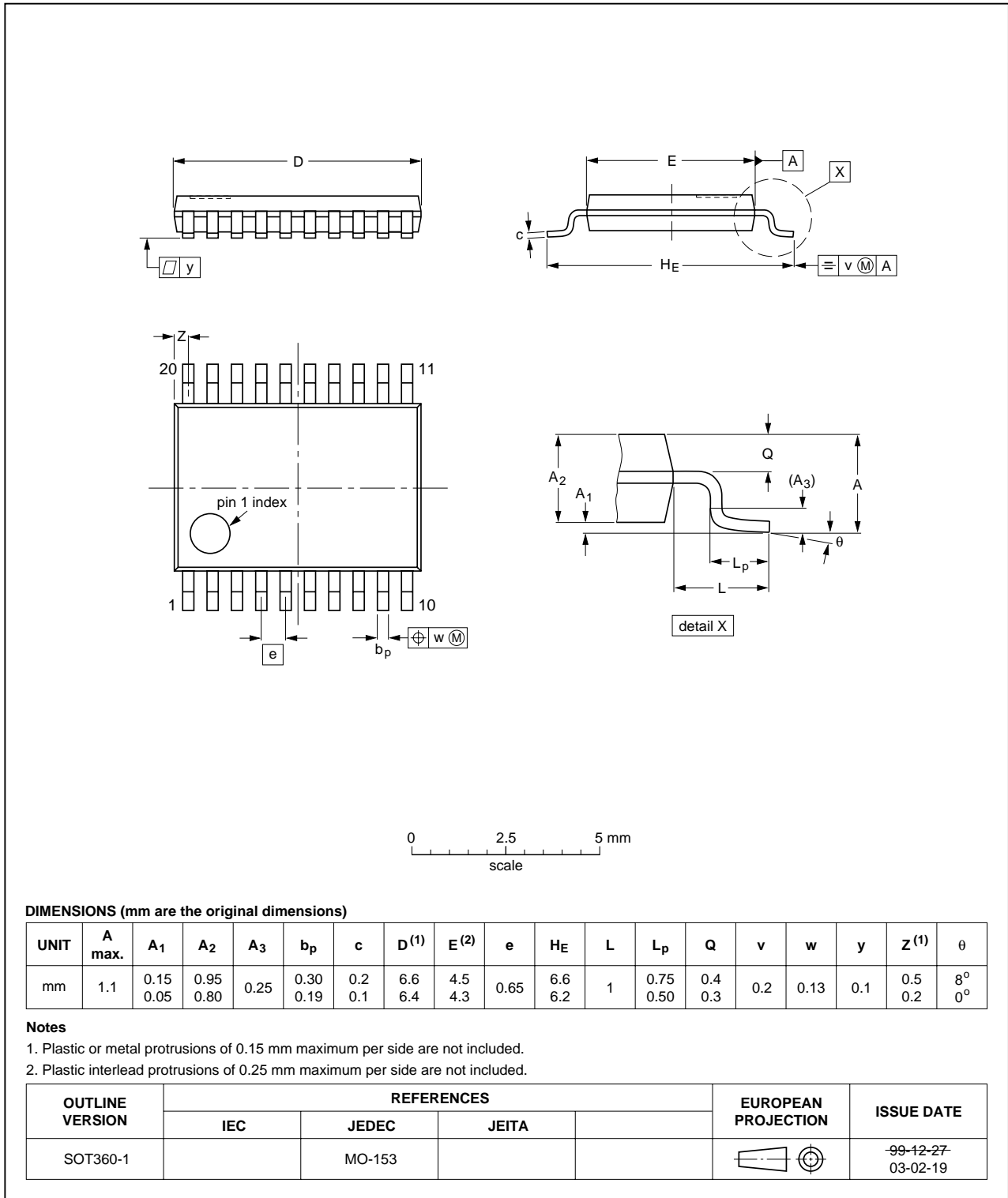

Fig 9. Package outline SOT360-1 (TSSOP20)

DHVQFN20: plastic dual in-line compatible thermal enhanced very thin quad flat package; no leads; 20 terminals; body 2.5 x 4.5 x 0.85 mm

SOT764-1

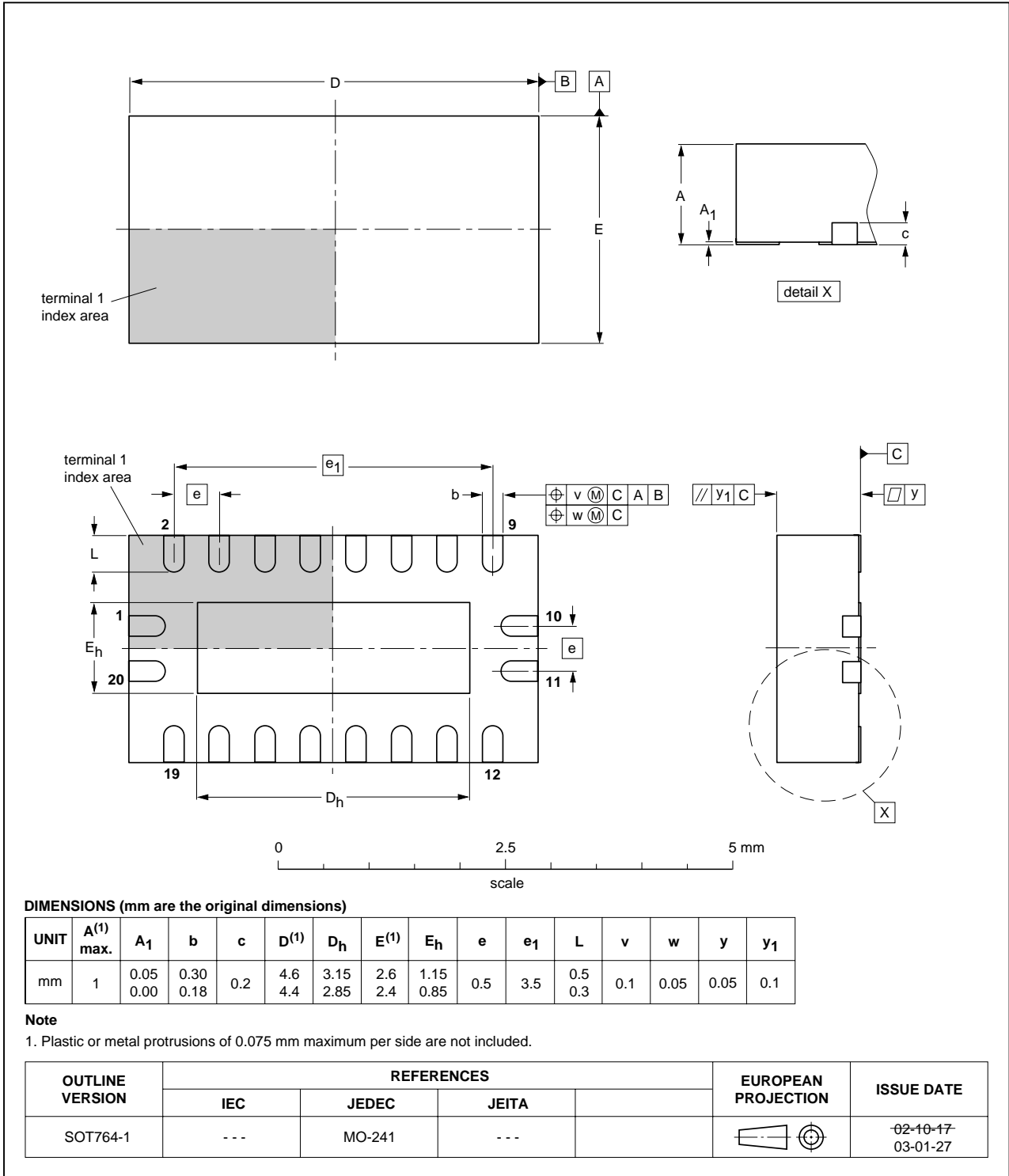

Fig 10. Package outline SOT764-1 (DHVQFN20)

13. Abbreviations

Table 10. Abbreviations

Acronym	Description
CDM	Charged-Device Model
CMOS	Complementary Metal Oxide Semiconductor
DUT	Device Under Test
ESD	ElectroStatic Discharge
HBM	Human Body Model
MM	Machine Model
TTL	Transistor-Transistor Logic

14. Revision history

Table 11. Revision history

Document ID	Release date	Data sheet status	Change notice	Supersedes
74ALVC541_2	20071105	Product data sheet	-	74ALVC541_1
Modifications:		<ul style="list-style-type: none">• The format of this data sheet has been redesigned to comply with the new identity guidelines of NXP Semiconductors.• Legal texts have been adapted to the new company name where appropriate.• Section 3: DHVQFN20 package added.• Section 8: derating values added for DHVQFN20 package.• Section 12: outline drawing added for DHVQFN20 package.		
74ALVC541_1	20020226	Product specification	-	-

15. Legal information

15.1 Data sheet status

Document status ^{[1][2]}	Product status ^[3]	Definition
Objective [short] data sheet	Development	This document contains data from the objective specification for product development.
Preliminary [short] data sheet	Qualification	This document contains data from the preliminary specification.
Product [short] data sheet	Production	This document contains the product specification.

[1] Please consult the most recently issued document before initiating or completing a design.

[2] The term 'short data sheet' is explained in section "Definitions".

[3] The product status of device(s) described in this document may have changed since this document was published and may differ in case of multiple devices. The latest product status information is available on the Internet at URL <http://www.nxp.com>.

15.2 Definitions

Draft — The document is a draft version only. The content is still under internal review and subject to formal approval, which may result in modifications or additions. NXP Semiconductors does not give any representations or warranties as to the accuracy or completeness of information included herein and shall have no liability for the consequences of use of such information.

Short data sheet — A short data sheet is an extract from a full data sheet with the same product type number(s) and title. A short data sheet is intended for quick reference only and should not be relied upon to contain detailed and full information. For detailed and full information see the relevant full data sheet, which is available on request via the local NXP Semiconductors sales office. In case of any inconsistency or conflict with the short data sheet, the full data sheet shall prevail.

15.3 Disclaimers

General — Information in this document is believed to be accurate and reliable. However, NXP Semiconductors does not give any representations or warranties, expressed or implied, as to the accuracy or completeness of such information and shall have no liability for the consequences of use of such information.

Right to make changes — NXP Semiconductors reserves the right to make changes to information published in this document, including without limitation specifications and product descriptions, at any time and without notice. This document supersedes and replaces all information supplied prior to the publication hereof.

Suitability for use — NXP Semiconductors products are not designed, authorized or warranted to be suitable for use in medical, military, aircraft, space or life support equipment, nor in applications where failure or

malfunction of an NXP Semiconductors product can reasonably be expected to result in personal injury, death or severe property or environmental damage. NXP Semiconductors accepts no liability for inclusion and/or use of NXP Semiconductors products in such equipment or applications and therefore such inclusion and/or use is at the customer's own risk.

Applications — Applications that are described herein for any of these products are for illustrative purposes only. NXP Semiconductors makes no representation or warranty that such applications will be suitable for the specified use without further testing or modification.

Limiting values — Stress above one or more limiting values (as defined in the Absolute Maximum Ratings System of IEC 60134) may cause permanent damage to the device. Limiting values are stress ratings only and operation of the device at these or any other conditions above those given in the Characteristics sections of this document is not implied. Exposure to limiting values for extended periods may affect device reliability.

Terms and conditions of sale — NXP Semiconductors products are sold subject to the general terms and conditions of commercial sale, as published at <http://www.nxp.com/profile/terms>, including those pertaining to warranty, intellectual property rights infringement and limitation of liability, unless explicitly otherwise agreed to in writing by NXP Semiconductors. In case of any inconsistency or conflict between information in this document and such terms and conditions, the latter will prevail.

No offer to sell or license — Nothing in this document may be interpreted or construed as an offer to sell products that is open for acceptance or the grant, conveyance or implication of any license under any copyrights, patents or other industrial or intellectual property rights.

15.4 Trademarks

Notice: All referenced brands, product names, service names and trademarks are the property of their respective owners.

16. Contact information

For additional information, please visit: <http://www.nxp.com>

For sales office addresses, send an email to: salesaddresses@nxp.com

17. Contents

1 General description 1

2 Features 1

3 Ordering information 1

4 Functional diagram 2

5 Pinning information 3

5.1 Pinning 3

5.2 Pin description 3

6 Functional description 4

7 Limiting values 4

8 Recommended operating conditions 5

9 Static characteristics 5

10 Dynamic characteristics 6

11 Waveforms 7

12 Package outline 10

13 Abbreviations 13

14 Revision history 13

15 Legal information 14

15.1 Data sheet status 14

15.2 Definitions 14

15.3 Disclaimers 14

15.4 Trademarks 14

16 Contact information 14

17 Contents 15

Please be aware that important notices concerning this document and the product(s) described herein, have been included in section 'Legal information'.



© NXP B.V. 2007.

All rights reserved.

For more information, please visit: <http://www.nxp.com>

For sales office addresses, please send an email to: salesaddresses@nxp.com

Date of release: 5 November 2007

Document identifier: 74ALVC541_2